

ANNEXES

APPENDICES

AMENAGEMENT / LAYOUT OFFSET SALOON

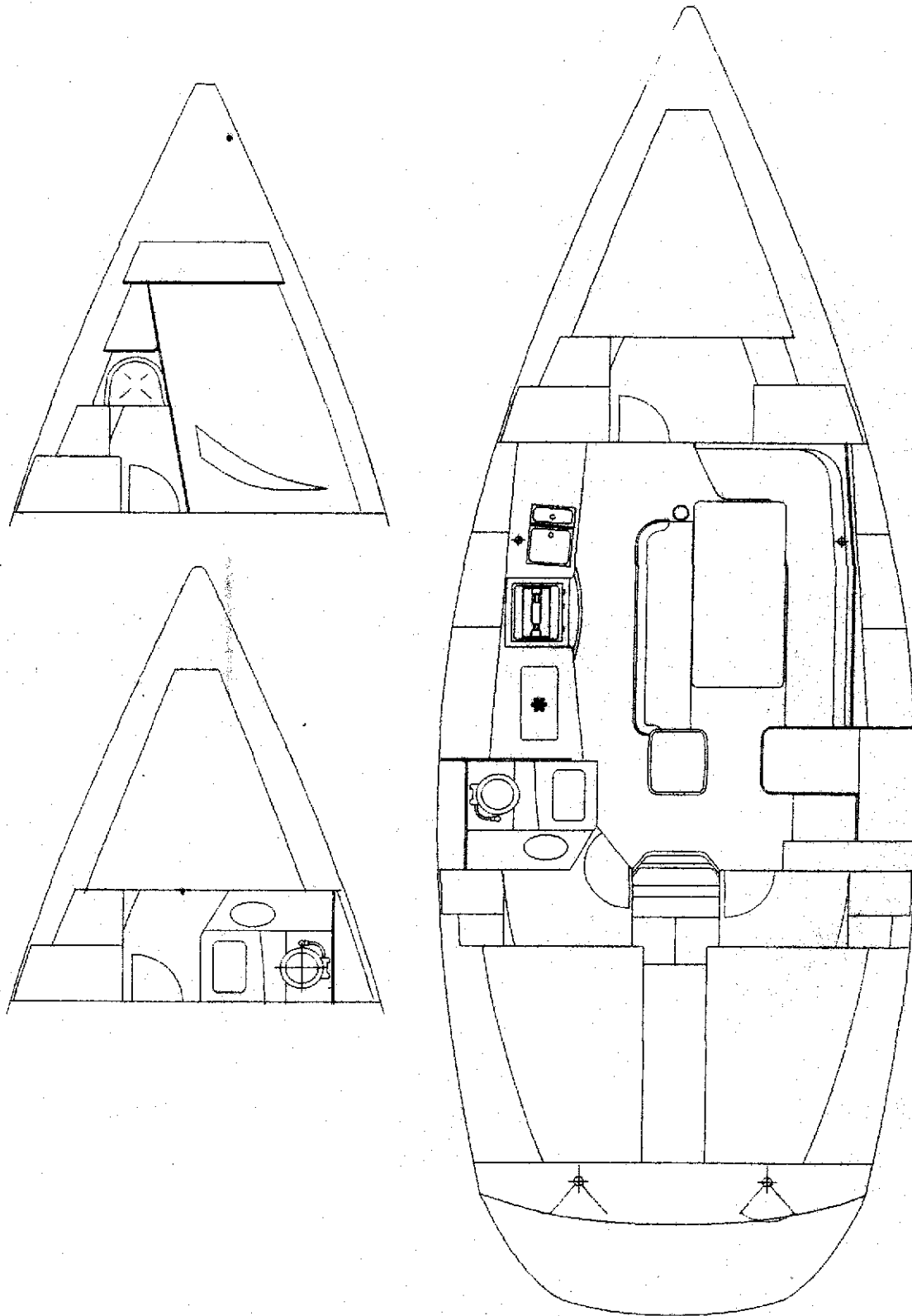

AMMENAGEMENT TABLES A CARTES CENTRALE
LAYOUT CENTRAL CHART TABLE

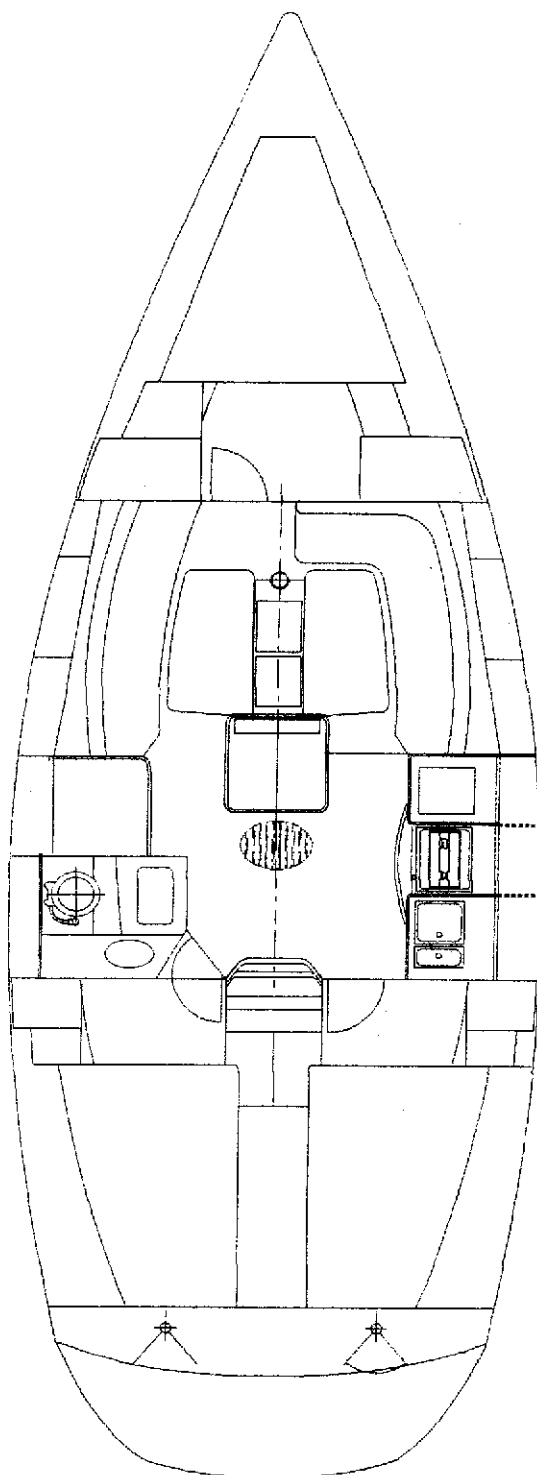

CIRCUIT 12 V 12V SYSTEM

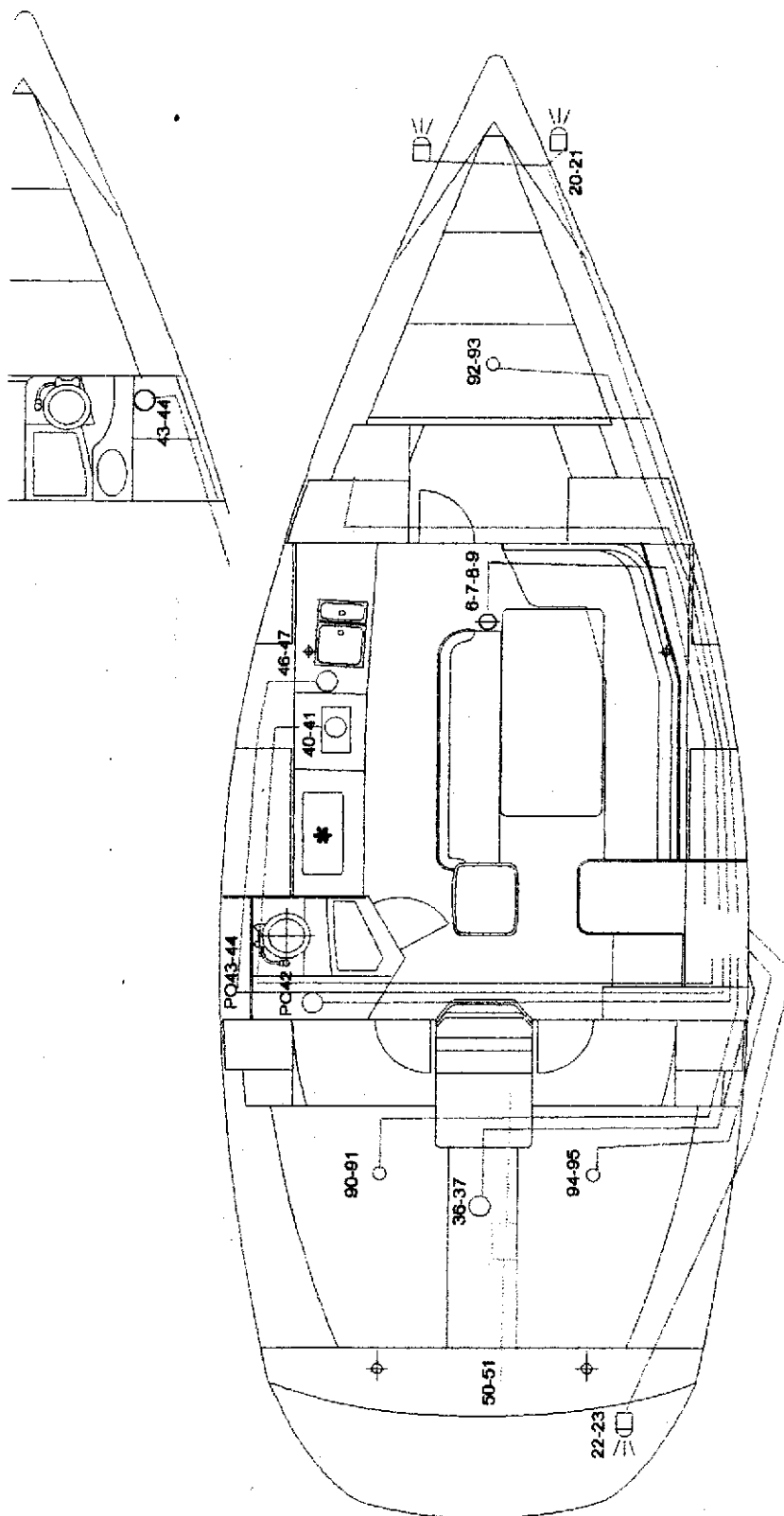



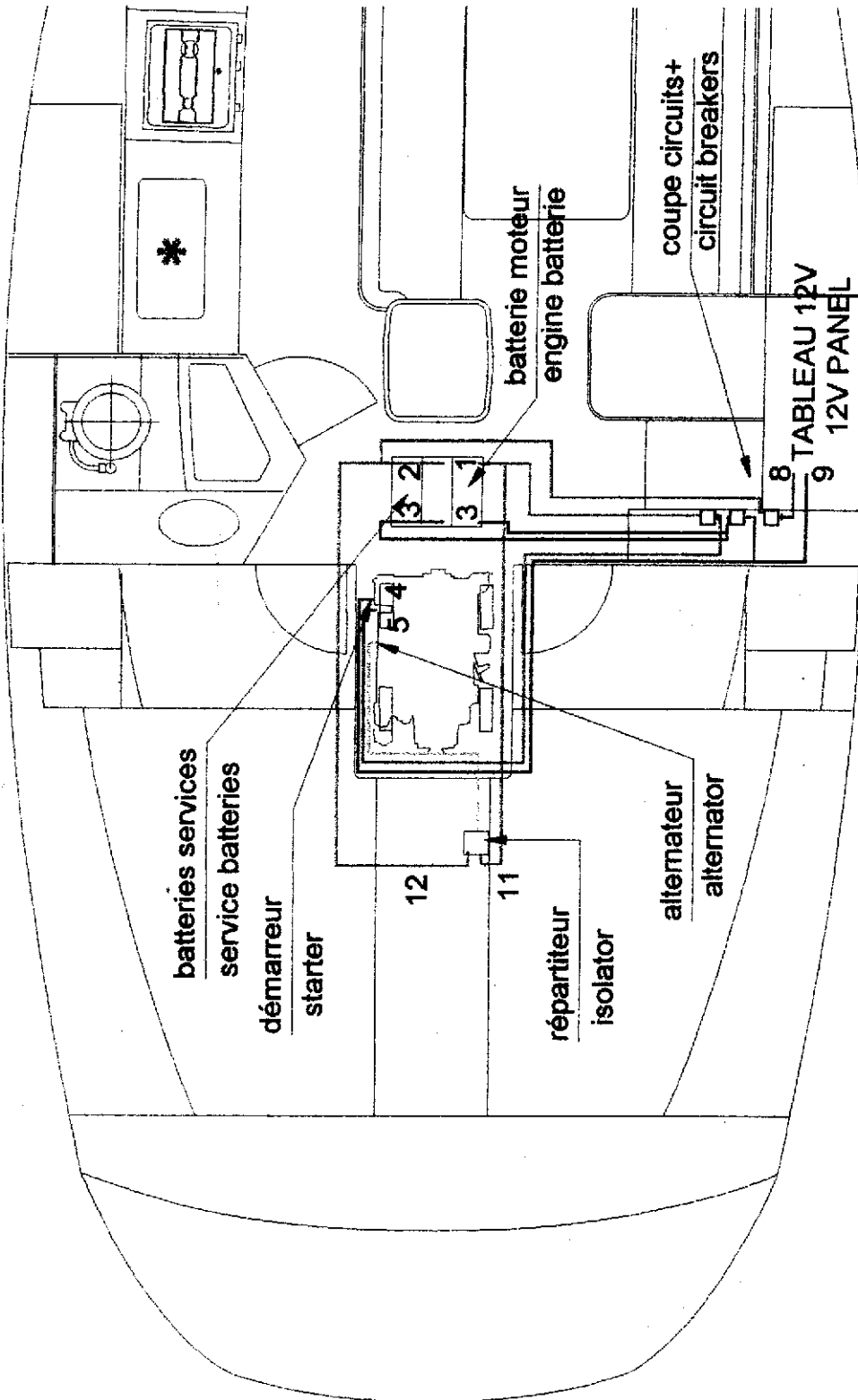

CIRCUIT DE CHARGE CHARGING SYSTEM

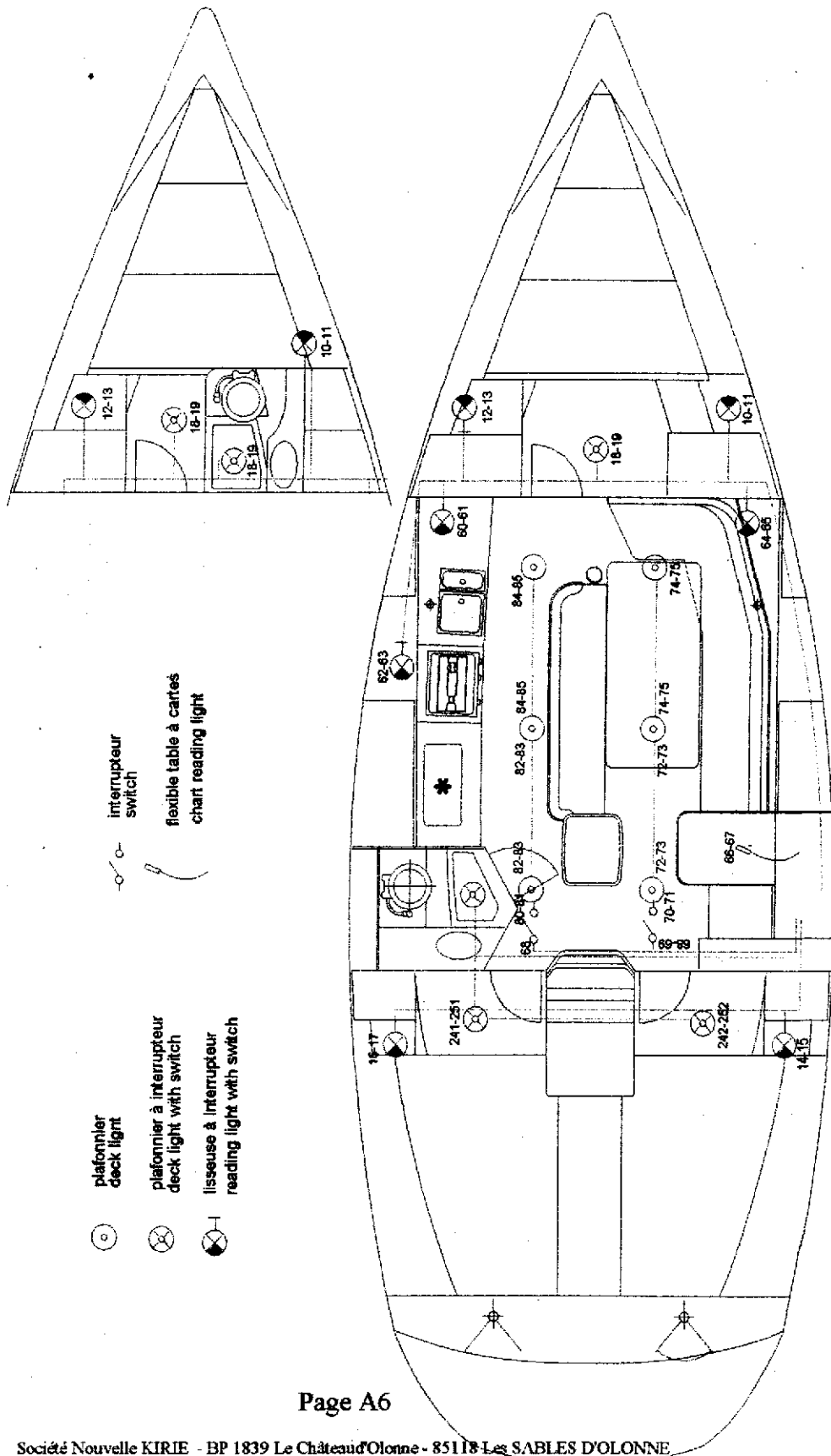

ECLAIRAGE LIGHTING



- 
 plafonnier
deck light
- 
 plafonnier à interrupteur
deck light with switch
- 
 liseuse à interrupteur
reading light with switch
- 
 interrupteur
switch
- 
 flexible table à cartes
chart reading light

CIRCUIT 230V AC 230V AC SYSTEM

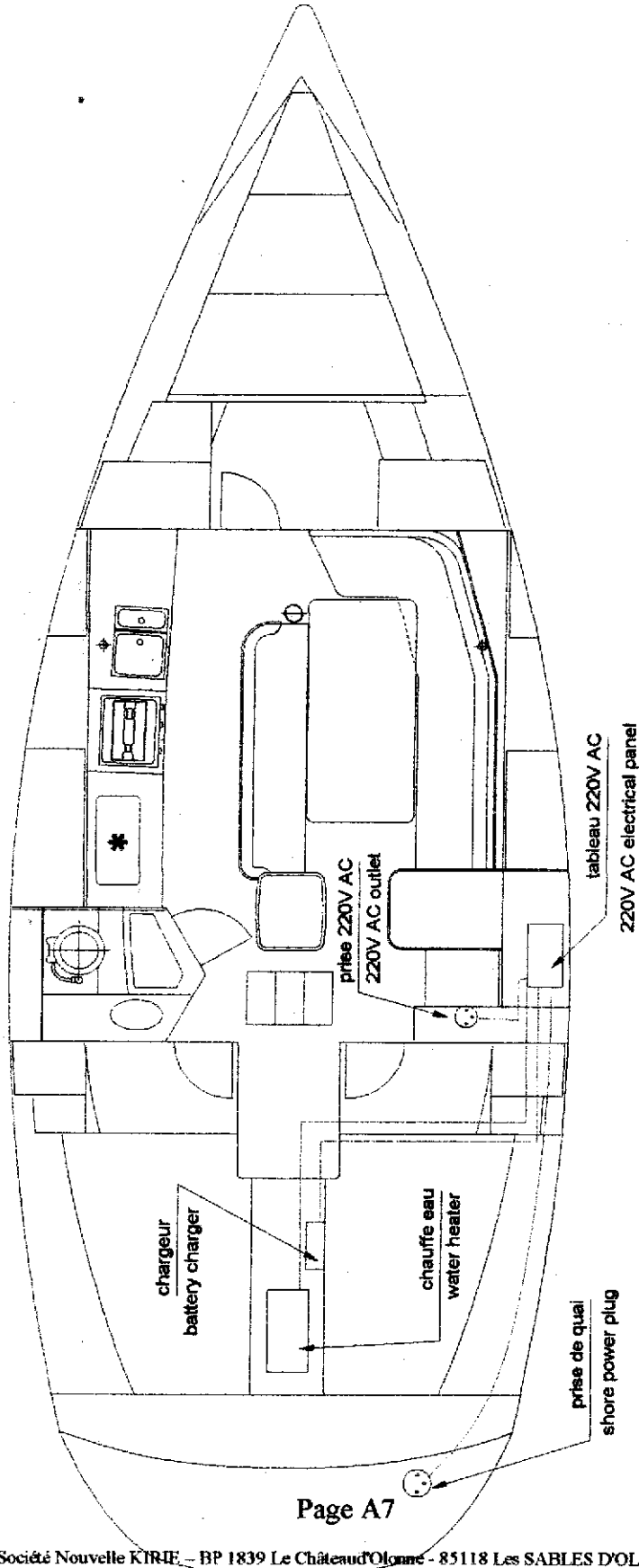

GUINDEAU WINDLASS

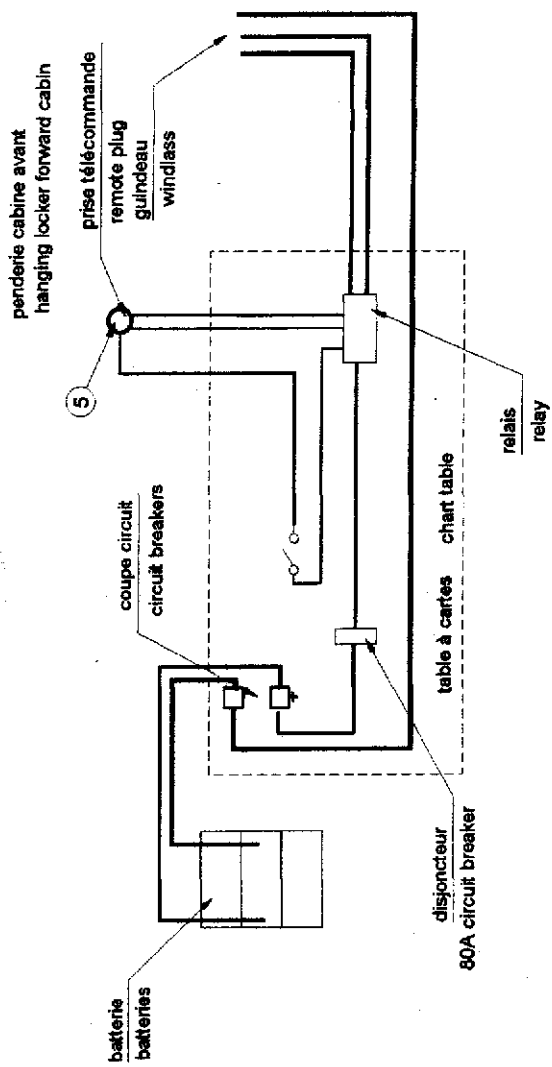

IMPLANTATION MOTEUR ENGINE INSTALLATION

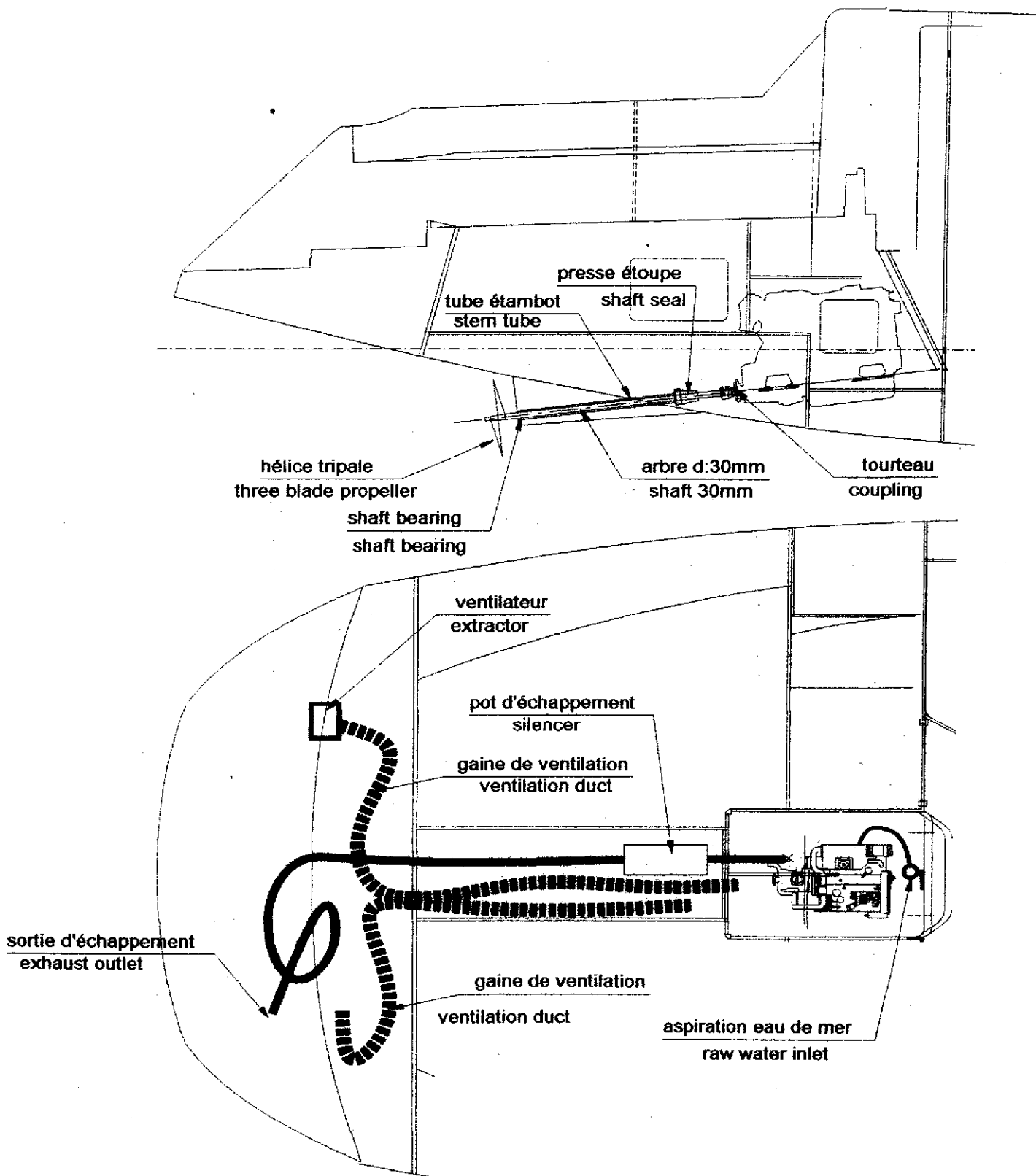

CIRCUIT GASOIL FUEL SYSTEM

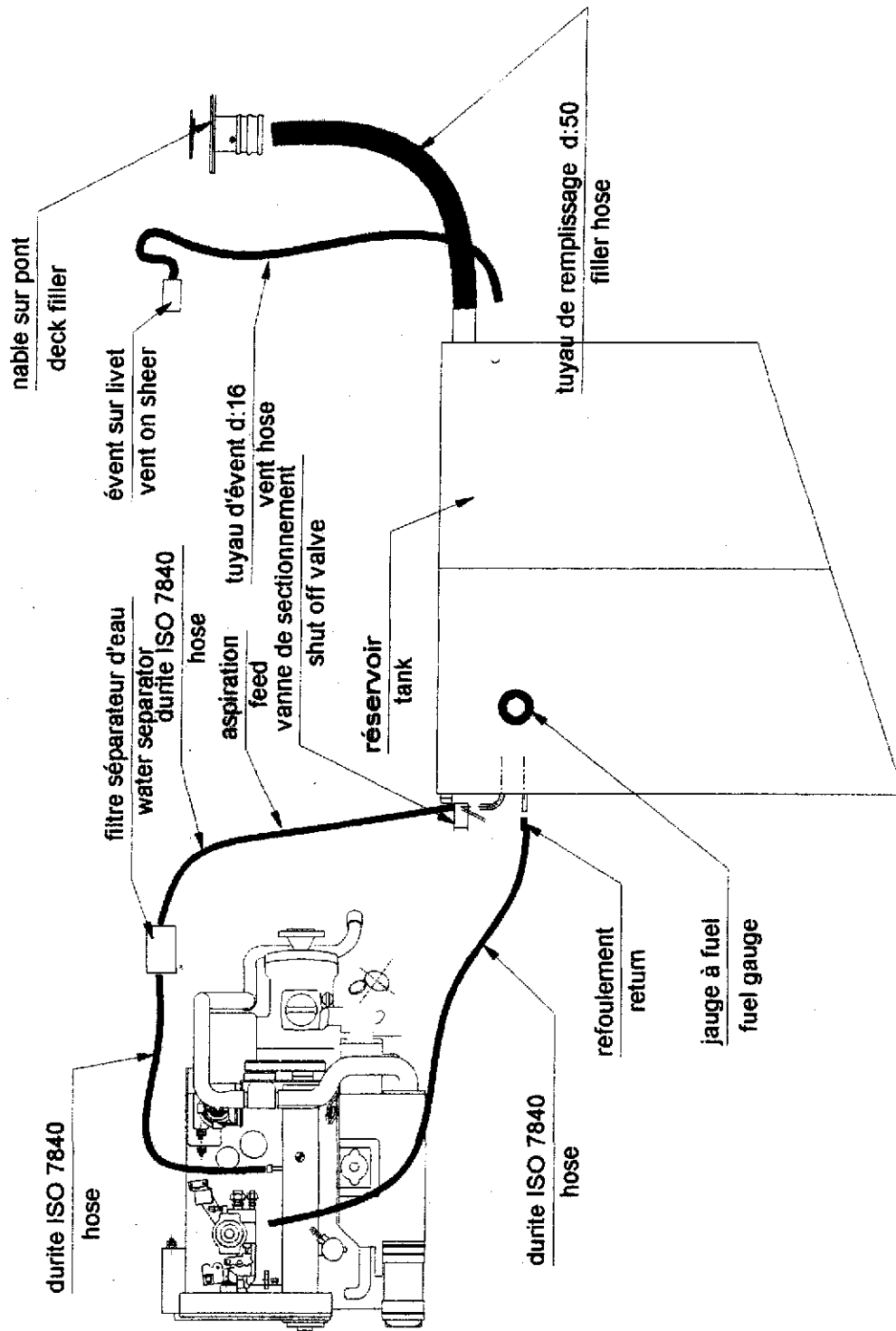

BARRE A ROUE version quillard
STEERING WHEEL fixed keel system

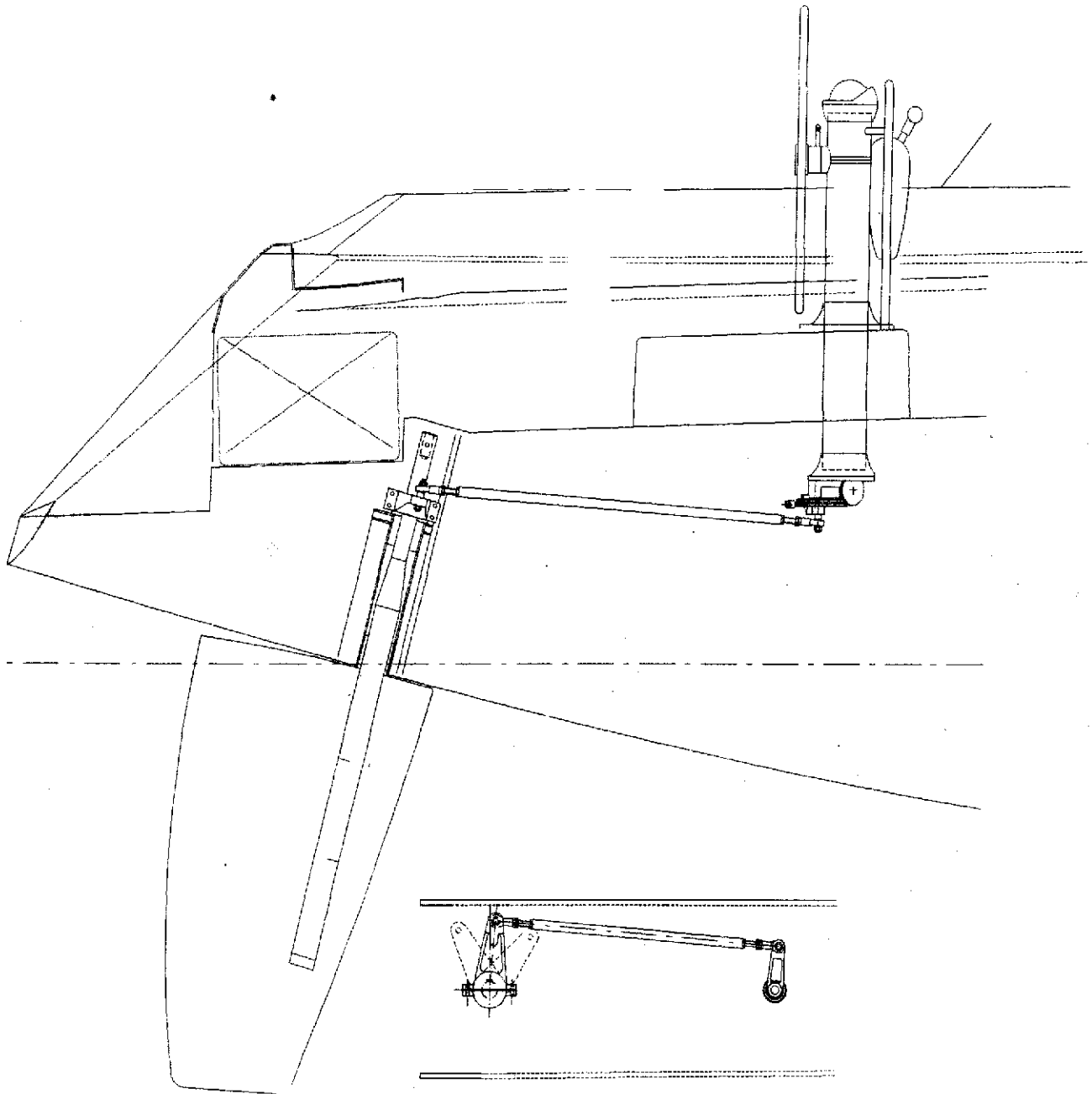

BARRE A ROUE version DI
STEERING WHEEL lifting keel version

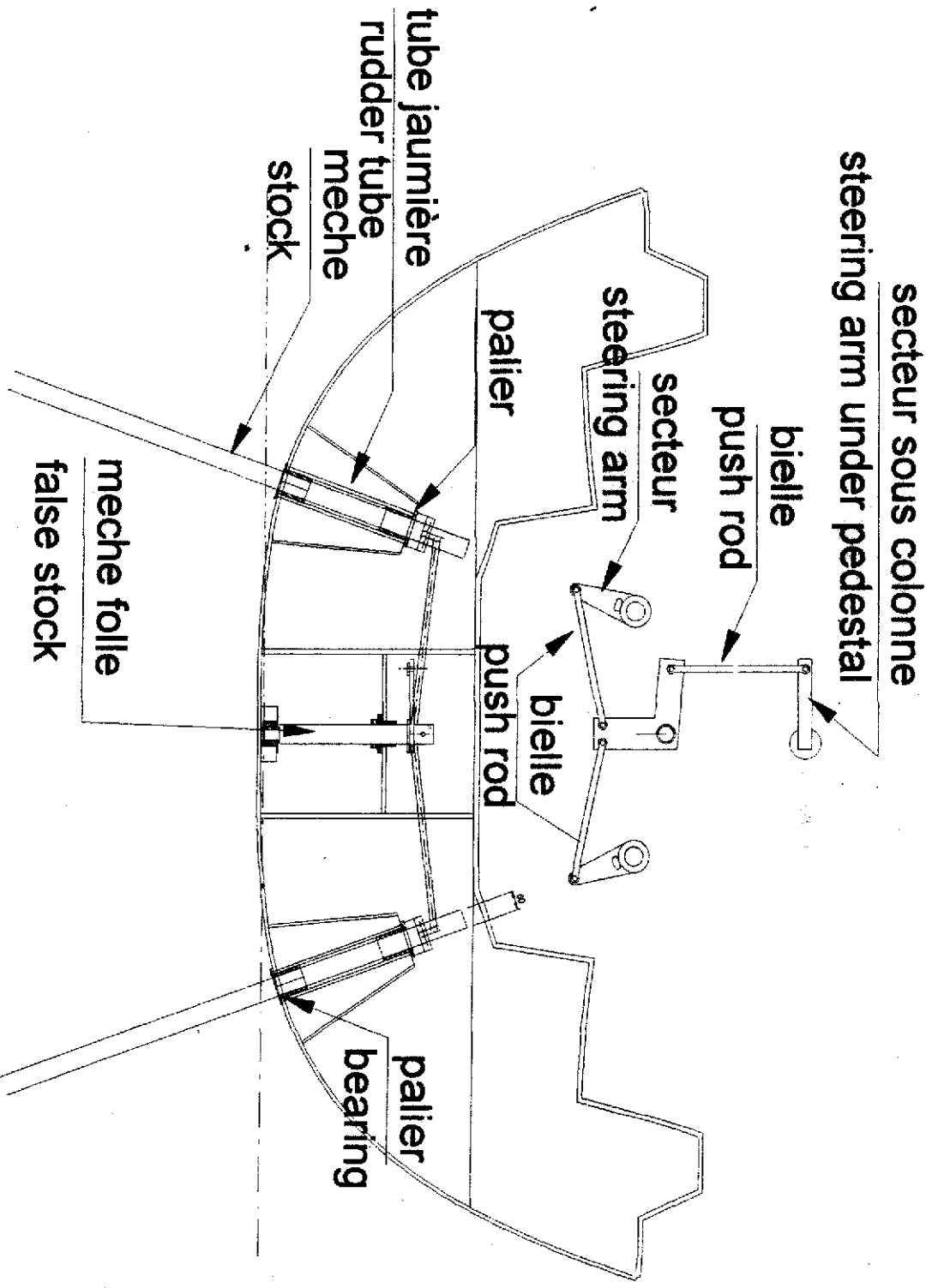

CIRCUIT GAZ GAS SYSTEM

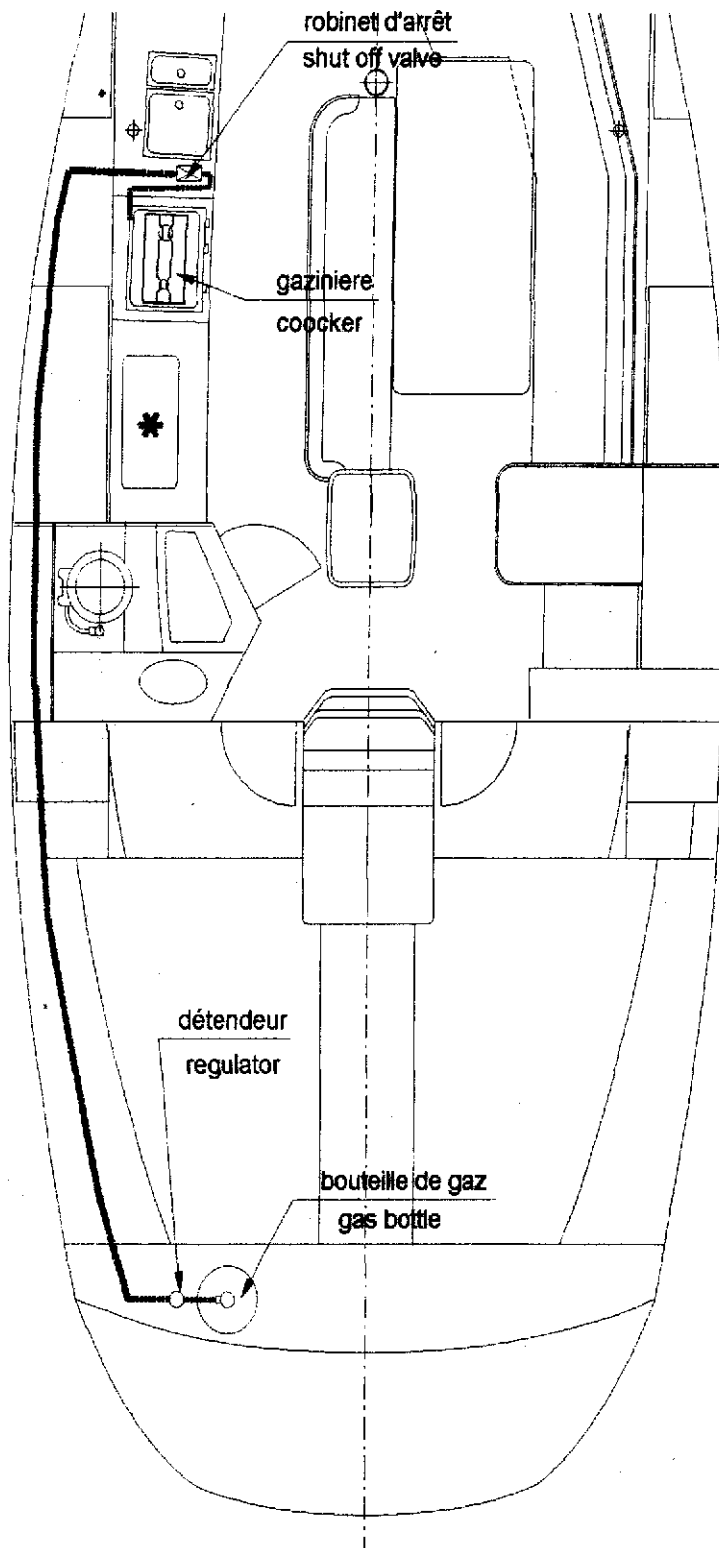

EAU DOUCE FRESH WATER

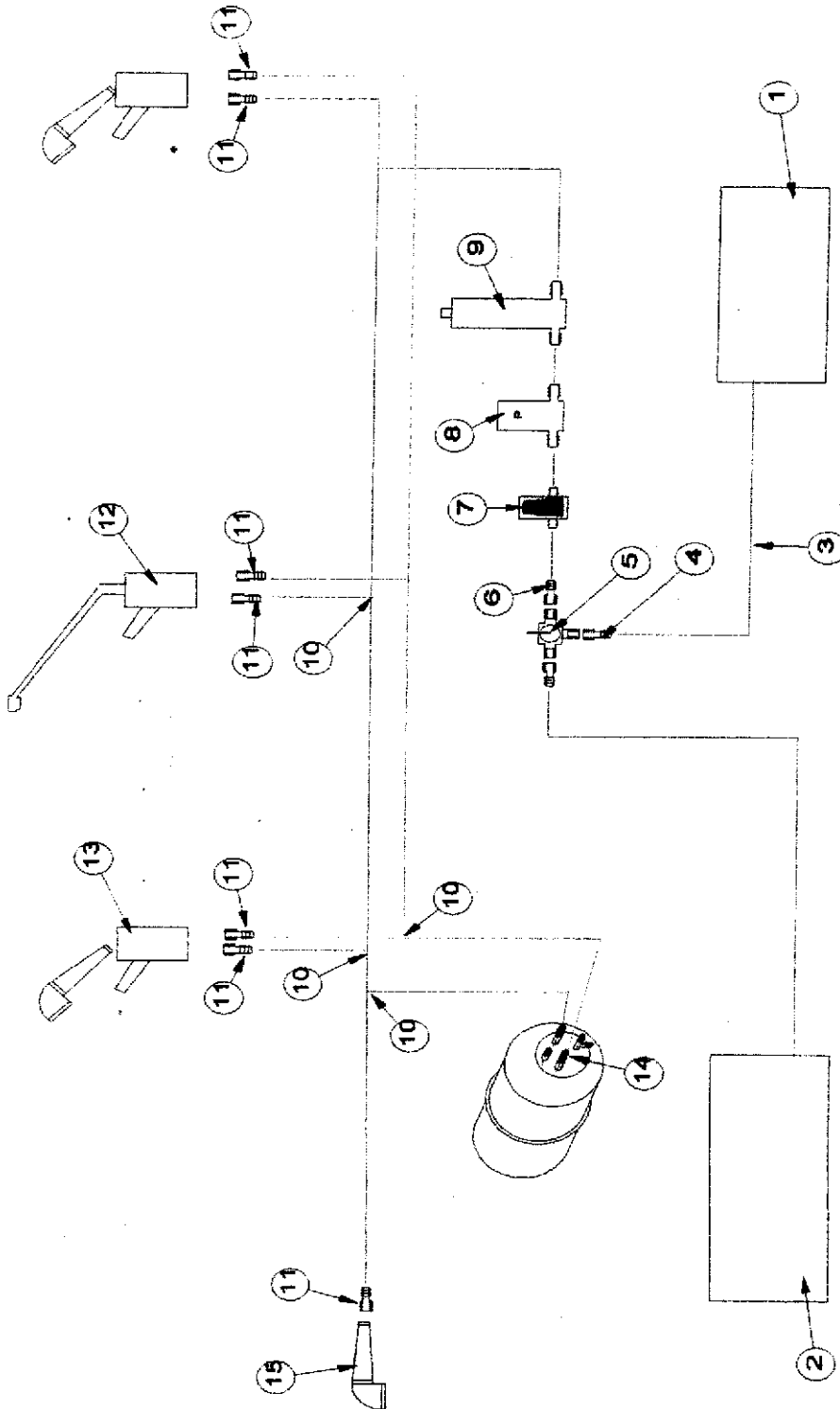

**WC
TOILET**

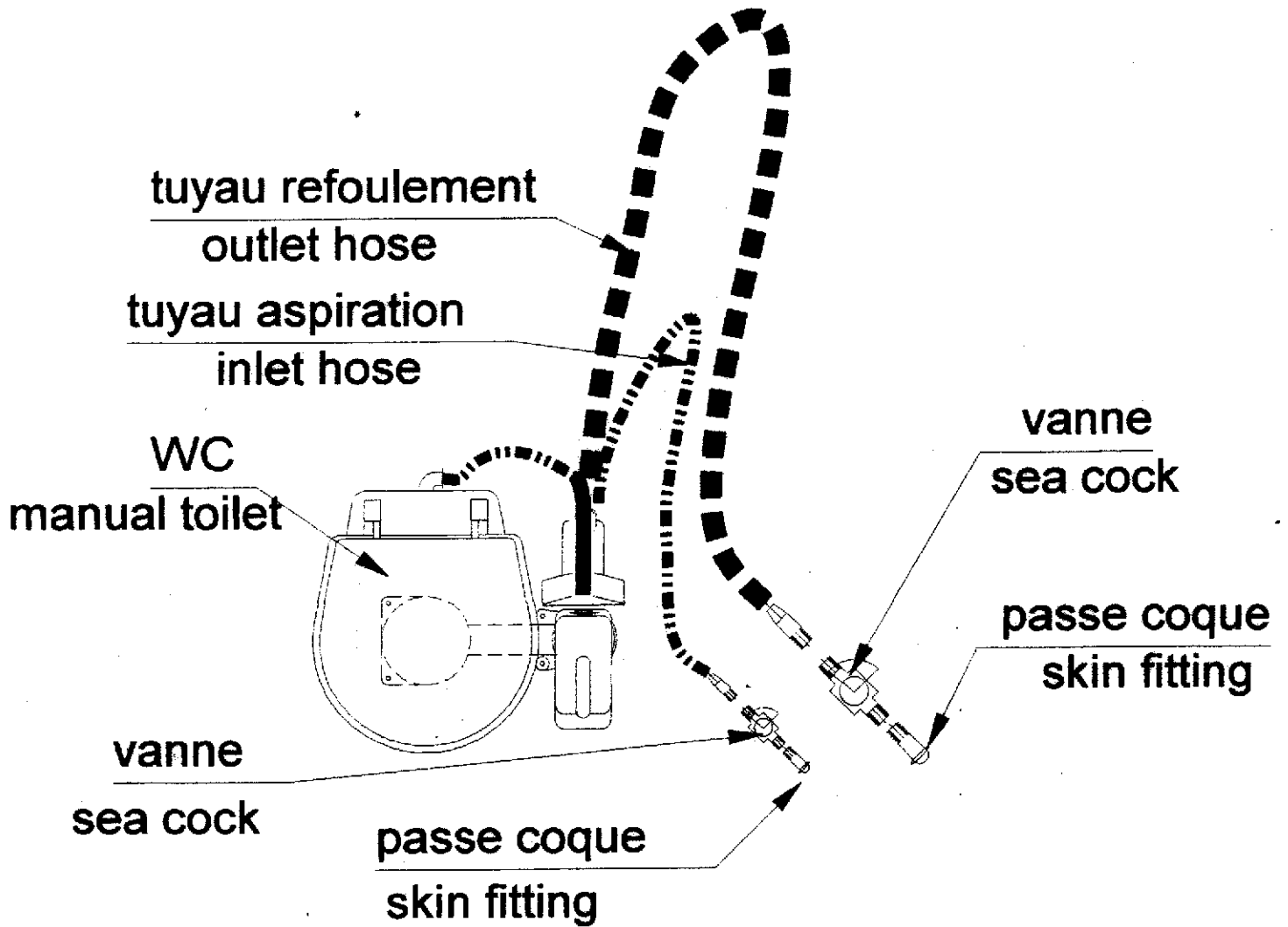

ASSECHEMENT BAILING

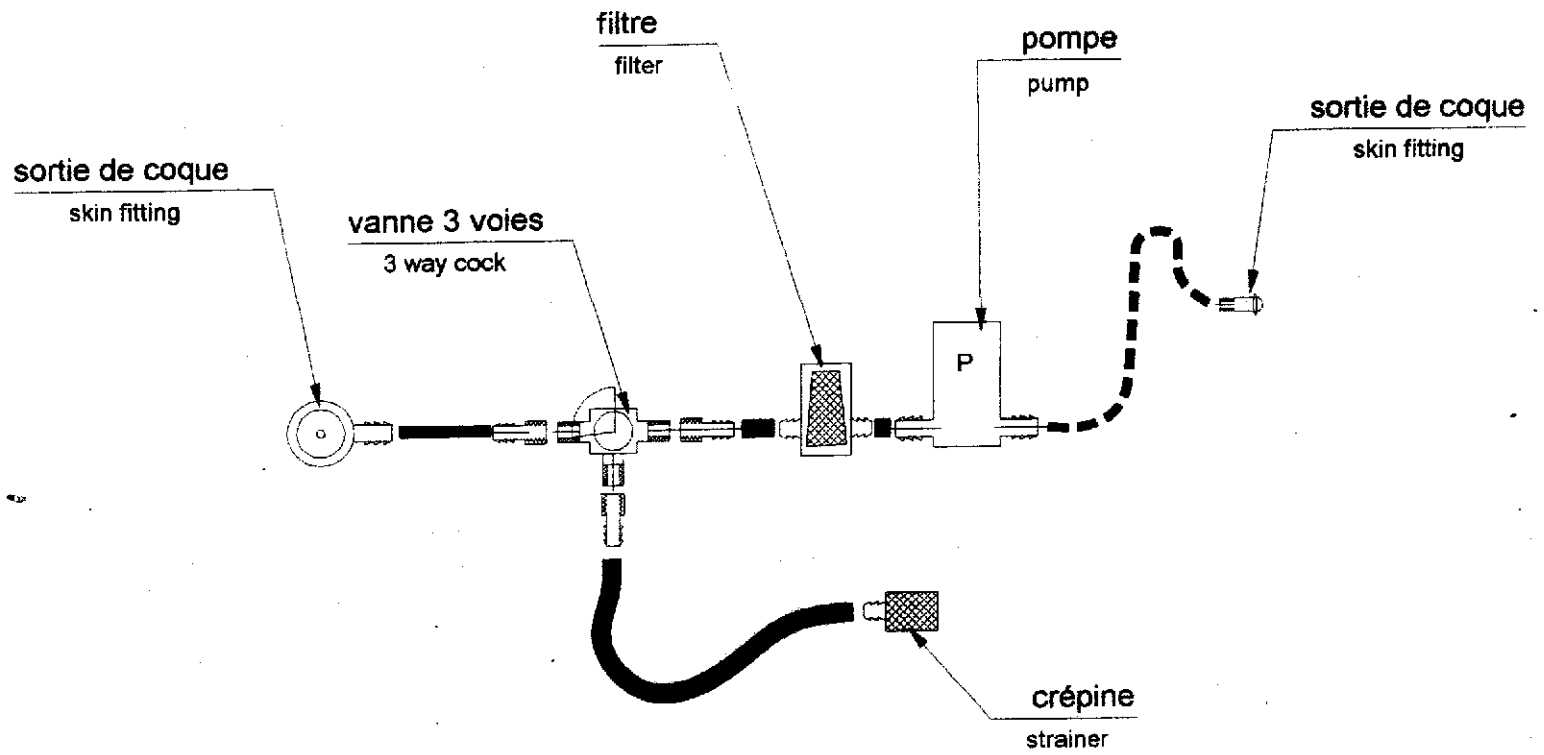

EVACUATION EVIER SINK DRINAGE

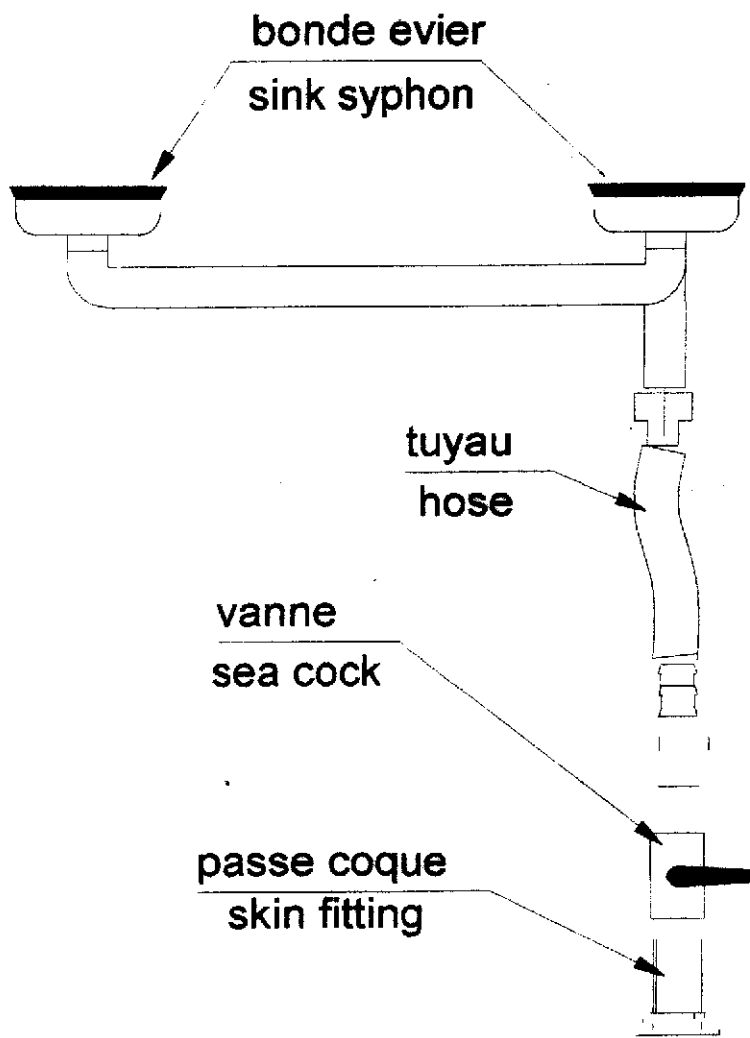

EVACUATION LAVABO WASHBASIN DRAINAGE

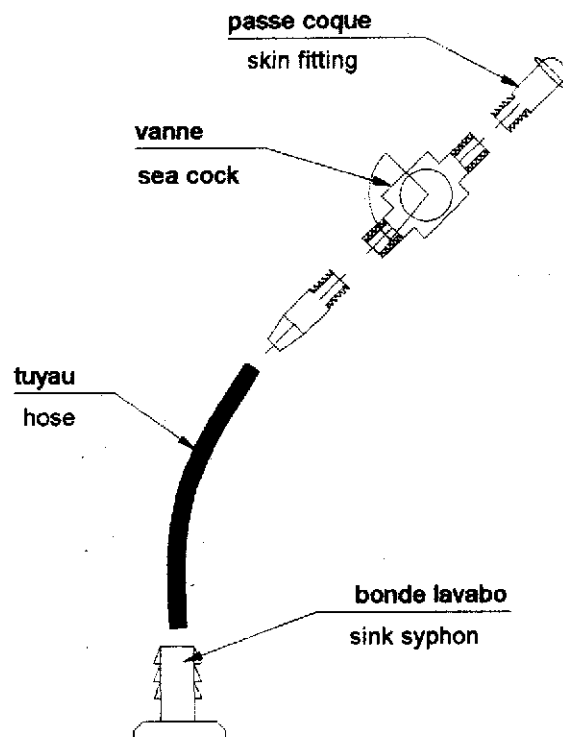

FEELING 39

I	14,35
J	4,29
P	13,65
E	4,10

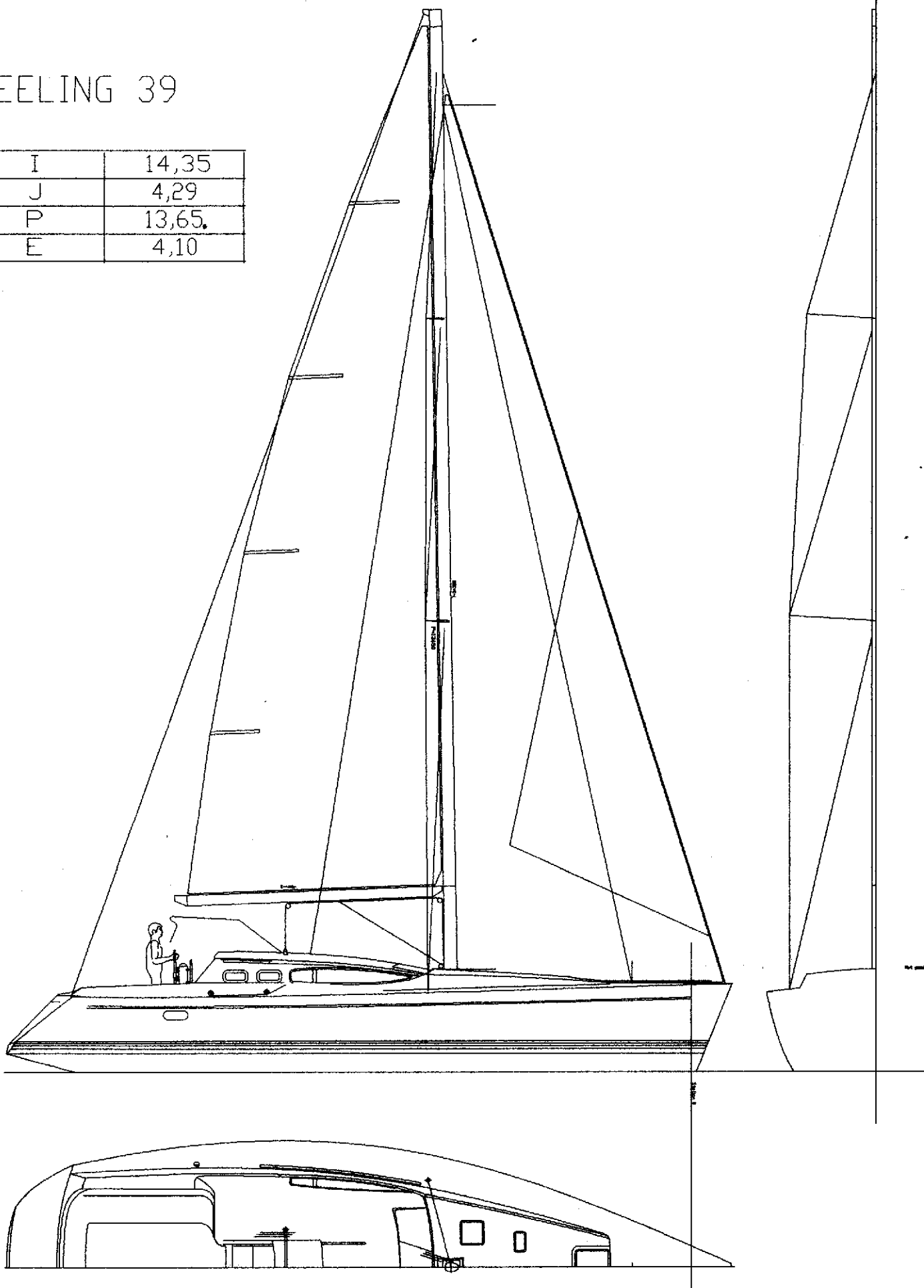

GREEMENT COURANT RUNNING RIGGING

Ecoute de GV / Mainsheet

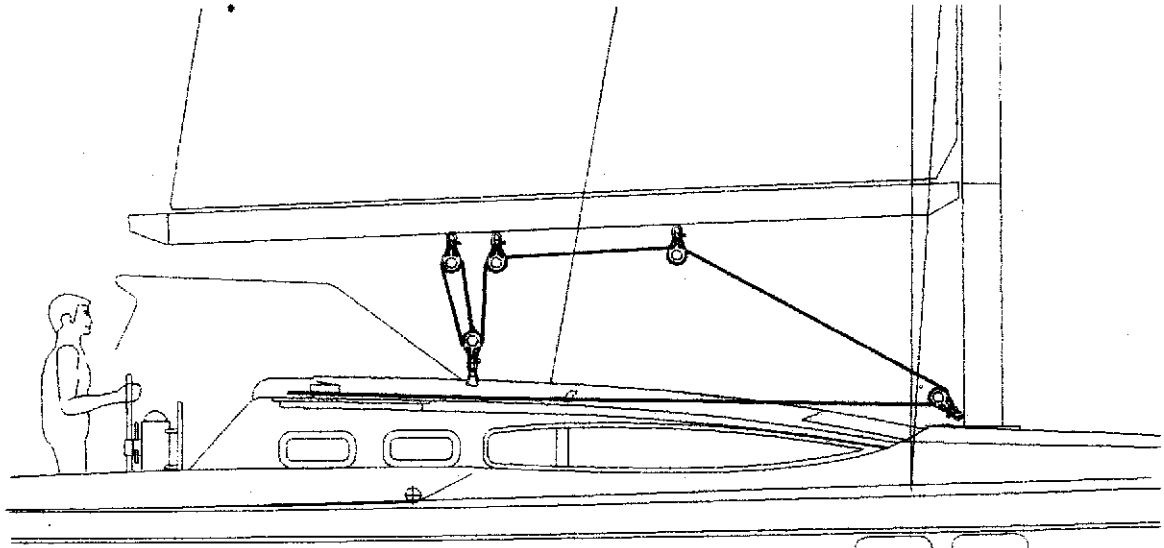

Retour de la drosse d'enrouleur de génois
Genoa control line return

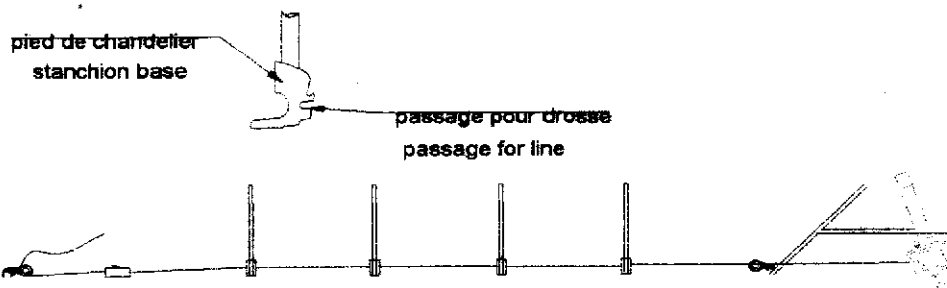

ACCASTILLAGE DECK FITTING

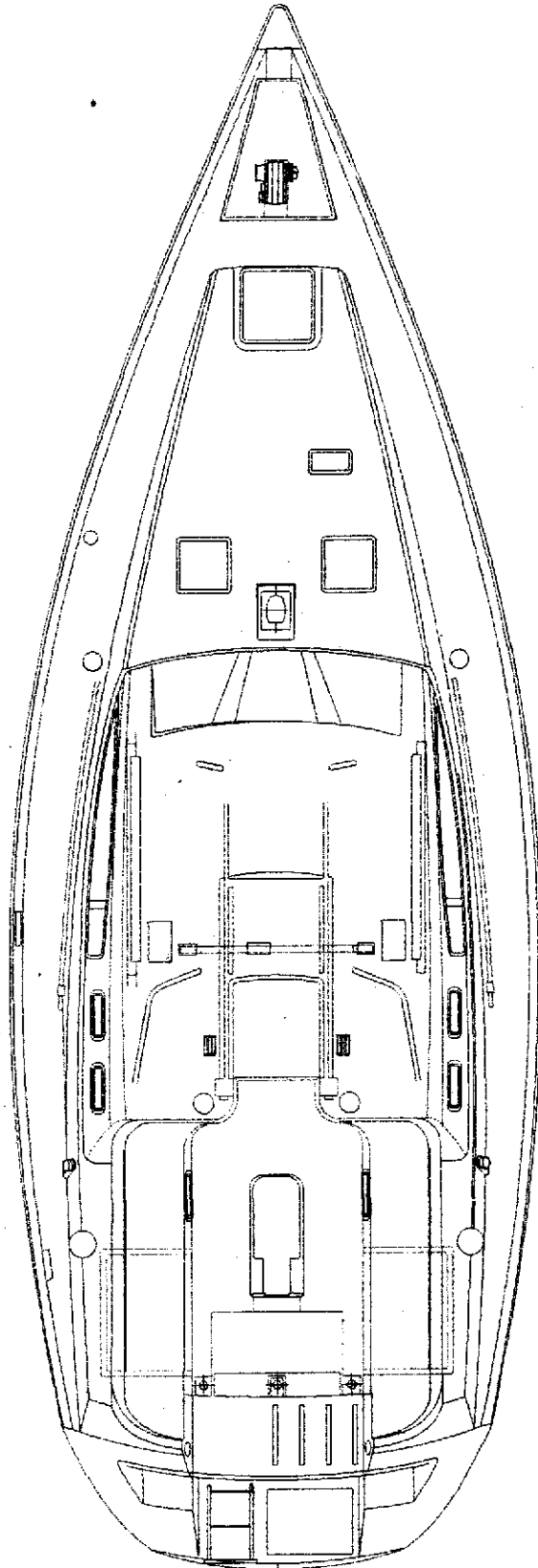

DERIVE CENTREBOARD

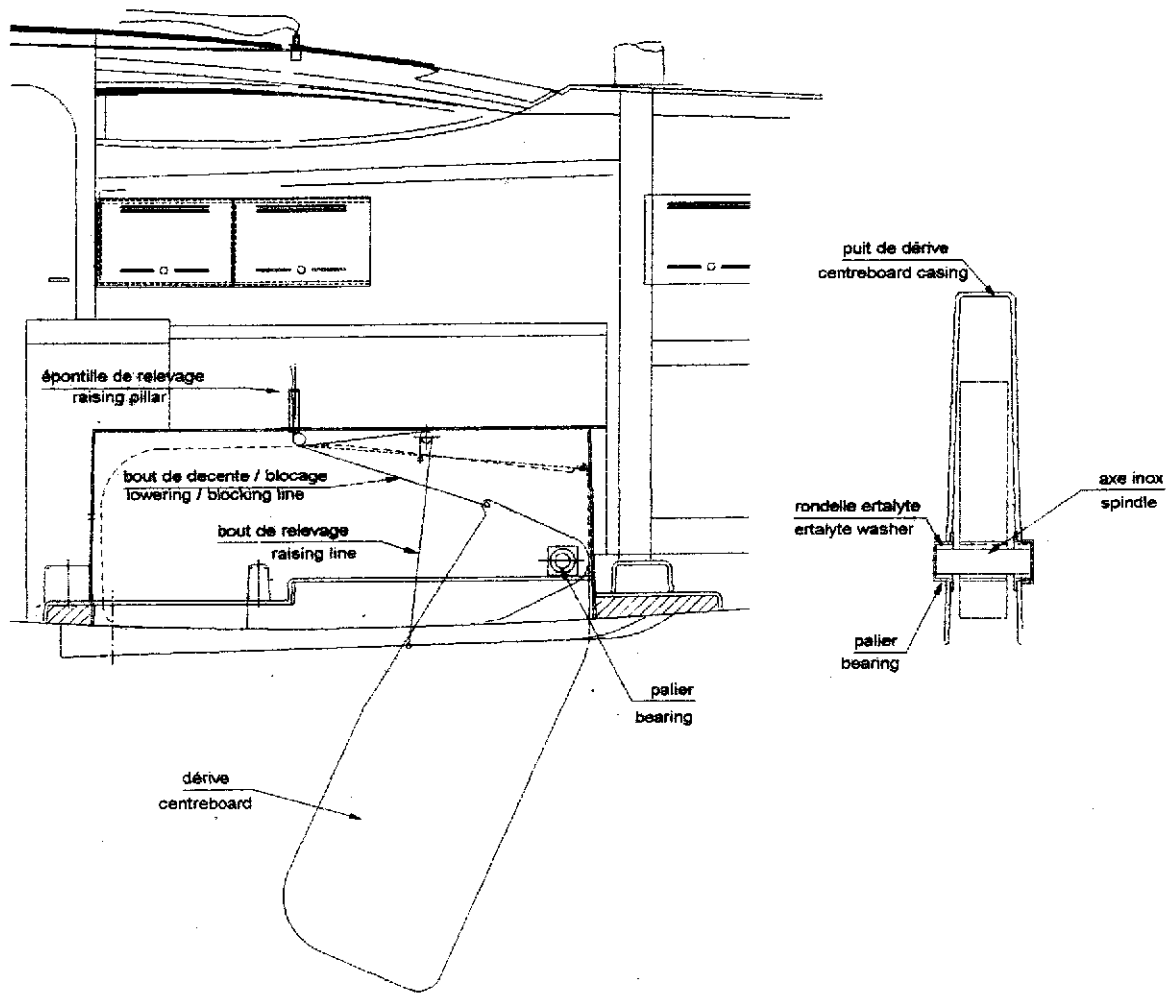

CENTREBOARD

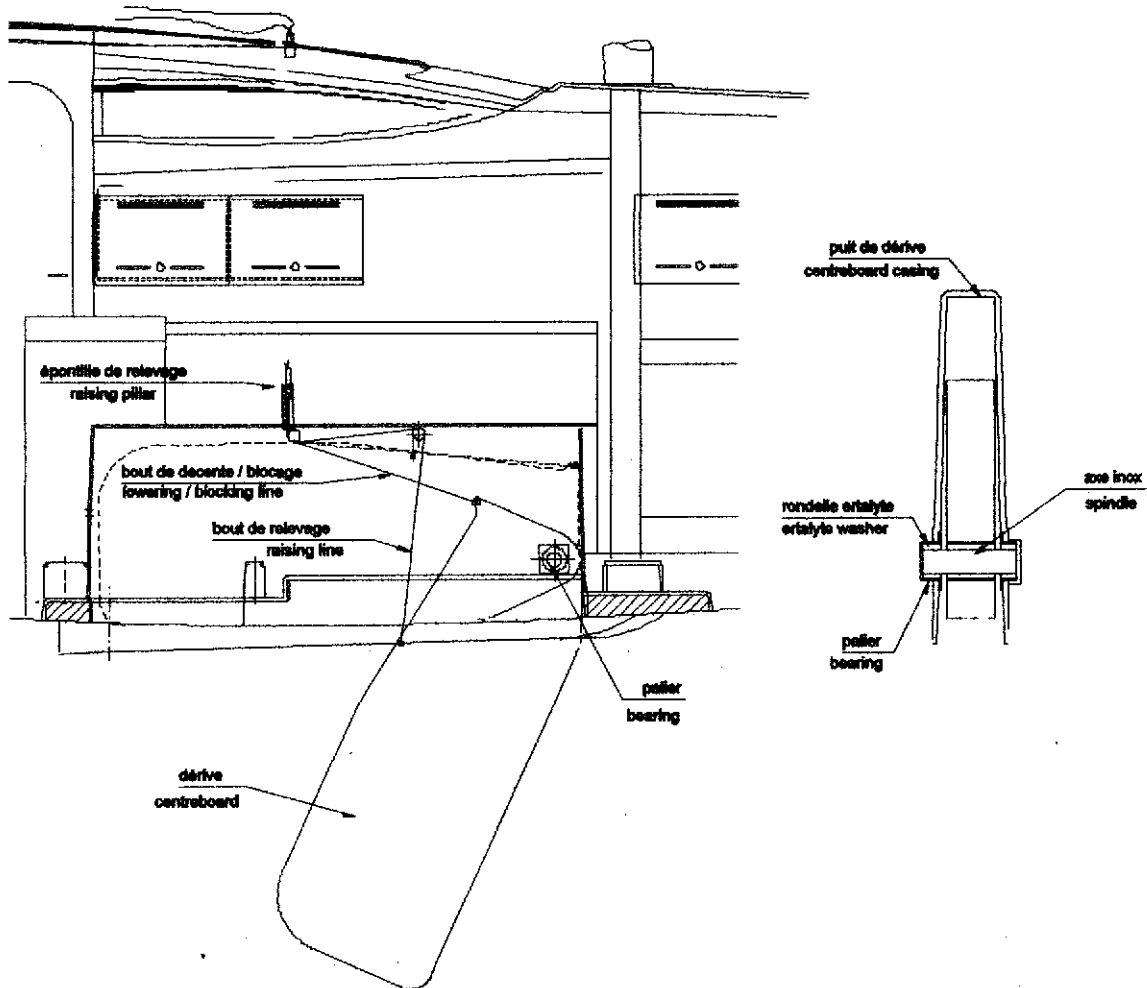

**CE BATEAU EST CONCU POUR
NAVIGUER DERIVE BASSE VERROUILLEE**

**THIS BOAT IS ONLY INTENDED
TO BE SAILED WITH THE CENTREBOARD
LOCKED IN THE LOWEST POSITION**